

# HIGH PERFORMANCE VANE PUMP VT67DCC



VT67DCC - B35 - 025 - 008 - 1 R 00 - A 1 - M1 - \*

**Series** - SAE C 2 bolts  
Mounting flange J744c

**Cam ring for "P1"**

Volumetric displacement cm<sup>3</sup> /rev (in<sup>3</sup> /rev)

B14 = 43.9 (2.68)	B31 = 99.1 (6.05)
B17 = 55.0(3.36)	B35 = 113.4 (6.92)
B20 = 66.0 (4.03)	B38 = 120.6 (7.36)
B22 = 70.3 (4.29)	B42 = 137.5 (8.39)
B24 = 81.1 (4.95)	045 = 145.7 (8.89)
B28 = 89.9 (5.49)	050 = 158.0 (9.64)

**Cam ring for "P2" & "P3"**

Volumetric displacement cm<sup>3</sup> /rev (in<sup>3</sup> /rev)

003 = 10.8(0.66)	015 = 50.5 (3.08)
005 = 17.2(1.05)	017 = 58.3 (3.56)
006 = 21.3 (1.30)	020 = 63.7 (3.89)
008 = 26.4 (1.61)	022 = 70.3 (4.29)
010 = 34.1 (2.08)	025 = 79.3 (4.84)
012 = 37.1 (2.26)	028 = 88.8 (5.42)
014 = 46.0 (2.81)	031 = 100 (6.10)

**Type of Shaft**

- 1 - Keyed (no SAE)
- 2 - Keyed (SAE CC)
- 3 - Splined (SAE C)
- 4 - Splined (SAE CC)

**Modifications**

**Mounting w/connection variables**  
4 bolts SAE flange J518

P1=1 1/4" - P2=1" -S=4"		
	UNC	METRIC
P3 =1"	00	M0
P3 =3/4"	01	M1

**Seal class**

- 1 = S1 (for mineral oil)
- 4 = S4(for fire resistant fluids)
- 5 = S5(for mineral oil and fire resistant fluids)

**Design letter**

**Porting combination (see page CI-1-4,5)**  
00 = Standard

**Direction of rotation (view on shaft end)**

- R - Clockwise
- L - Counter - clockwise



**OPERATING CHARACTERISTICS - TYPICAL (24 cST) (Input power p (KW) for one cartridge only)**

Pressure port	Series	Volumetric Displacement Vp		Flow q & n = 1800 rpm						Input power p & n = 1800 rpm					
				p = 0 bar (0 psi)		p = 140 bar (2000 psi)		p = 250 bar (3630 psi)		p = 7 bar (100 psi)		p = 140 bar (2000 psi)		p = 250 bar (3630 psi)	
				in <sup>3</sup> /rev	cm <sup>3</sup> /rev	gpm	lpm	gpm	lpm	gpm	lpm	hp	kw	hp	kw
P1	B14	2.68	43.93	20.92	79.50	19.18	72.9	17.81	67.7	3.46	2.6	27.77	20.7	47.03	35.1
	B17	3.36	55.07	26.16	99.4	24.41	92.8	23.04	87.6	3.77	2.8	33.88	25.3	57.71	43.1
	B20	4.03	66.05	31.39	119.3	29.64	112.6	28.27	107.4	4.07	3.0	39.98	29.8	68.39	51.0
	B22	4.29	70.31	33.43	127	31.69	120.4	30.32	115.2	4.19	3.1	42.37	31.6	72.57	54.1
	B24	4.95	81.13	38.57	146.6	36.82	139.9	35.45	134.7	4.49	3.3	48.36	36.1	83.06	62
	B28	5.49	89.98	42.8	162.6	41.06	156	39.69	150.8	4.74	3.5	53.30	39.8	91.7	68.4
	B31	6.05	99.16	47.18	179.3	45.43	172.6	42.06	167.4	4.99	3.7	58.41	43.6	100.63	75.1
	B35	6.92	113.42	53.93	204.9	52.18	198.3	50.81	193.1	5.39	4.0	66.29	49.5	114.42	85.4
	B38	7.36	120.63	57.35	217.9	55.61	211.3	54.24	206.1	5.59	4.2	70.28	52.4	121.42	90.6
	B42 <sup>1)</sup>	8.39	137.51	65.39	248.5	63.65	241.9	62.28	236.7	6.05	4.5	79.66	59.4	137.83	102.8
	045 <sup>1)</sup>	8.89	145.71	69.29	263.3	67.11	255.0	65.31	248.2	6.74	5.0	83.75	62.5	145.79	108.8
050 <sup>1,2)</sup>	9.64	158.00	75.14	285.5	72.96	277.2	71.78	272.8	7.08	5.3	90.58	67.6	134.5	100.3	
P2 & P3				p = 0 bar (0 psi)		p = 140 bar (2000 psi)		p = 275 bar (4000 psi)		p = 7 bar (100 psi)		p = 140 bar (2000 psi)		p = 275 bar (4000 psi)	
	003	0.66	10.82	5.14	19.53	3.85	14.63	--	--	2.11	1.6	8.45	6.3	--	--
	005	1.05	17.21	8.18	31.08	6.89	26.18	5.68	21.6	2.29	1.7	12.0	9.0	19.81	14.8
	006	1.30	21.31	10.13	38.49	8.84	33.59	7.63	29.0	2.4	1.8	14.28	10.7	23.79	17.7
	008	1.61	26.39	12.55	47.69	11.26	42.79	10.05	38.2	2.54	1.9	17.11	12.8	28.75	21.4
	010	2.08	34.09	16.22	61.64	14.93	56.73	13.71	52.1	2.76	2.1	21.38	15.9	36.22	27.0
	012	2.26	37.04	17.64	67.03	16.35	62.13	15.14	57.5	2.84	2.1	23.05	17.2	39.14	29.2
	014	2.81	46.06	21.88	83.14	20.59	78.24	19.37	73.6	3.09	2.3	27.99	20.9	47.78	35.6
	015	3.08	50.5	23.99	90.7	22.83	86.3	21.56	81.5	3.21	2.40	30.30	22.60	51.36	38.30
	017	3.56	58.35	27.73	105.37	26.44	100.47	25.22	95.8	3.43	2.6	34.81	26.0	59.73	44.6
	020	3.89	63.76	30.34	115.29	29.05	110.39	27.84	105.8	3.58	2.7	37.86	28.2	65.07	48.5
	022 <sup>4)</sup>	4.29	70.31	33.43	127.03	32.14	122.13	30.93	117.5	3.76	2.8	41.47	30.9	71.38	53.2
	025 <sup>3,5)</sup>	4.84	79.33	37.71	143.3	36.42	138.40	35.21	133.8	4.01	3.0	46.46	34.7	80.12	59.8
	028 <sup>3,6)</sup>	5.42	88.83	42.23	160.47	40.94	155.60	40.32	153.2	4.27	3.2	51.74	38.6	76.73	57.2
	031 <sup>3,6)</sup>	6.10	99.98	47.56	180.73	46.27	175.83	45.65	173.5	4.58	3.4	57.95	43.2	86.06	64.2

-- We do not recommend to use this 003 at 275 bar (4000 psi) and 1500 rpm since internal leakage is over 50% of theoretical flow.

- 1) 042-045-050 = 2200 RPM max.
- 2) 050=210 bar (3000 psi) max. int.
- 3) 025-028-031 = 2500 R.P.M. max.
- 4) 022= 275 bar max. int.
- 5) 025 = 240 bar max. int.
- 6) 028-031 = 210 bar (3000 psi) max. int.

## INTERNAL LEAKAGE (TYPICAL)

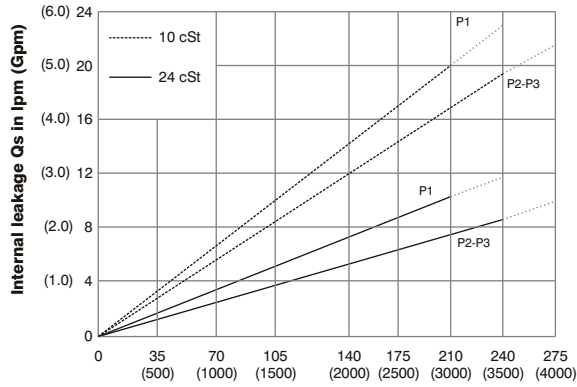

Pressure in bar (psi)

Do not operate pump more than 5 seconds at any speed or viscosity if internal leakage is more than 50% of theoretical flow. Total leakage is the sum of each section loss at its operating conditions.

## NOISE LEVEL (TYPICAL)

VT67DCC- B31-022-022

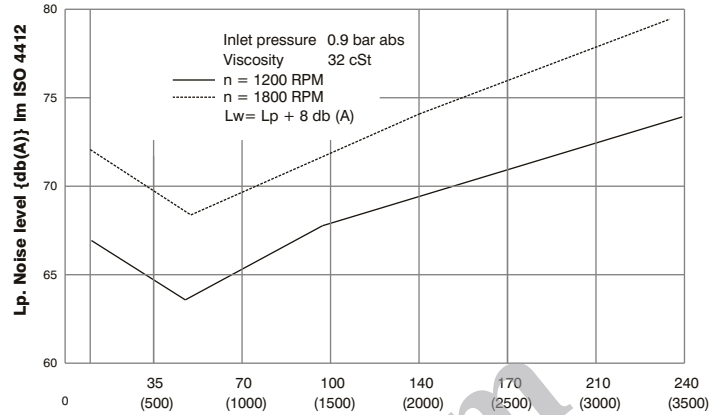

Pressure in bar (psi)

Triple pump noise level is given with each section discharging at the pressure noted on the curve.

## HYDROMECHANICAL POWER LOSS (TYPICAL)

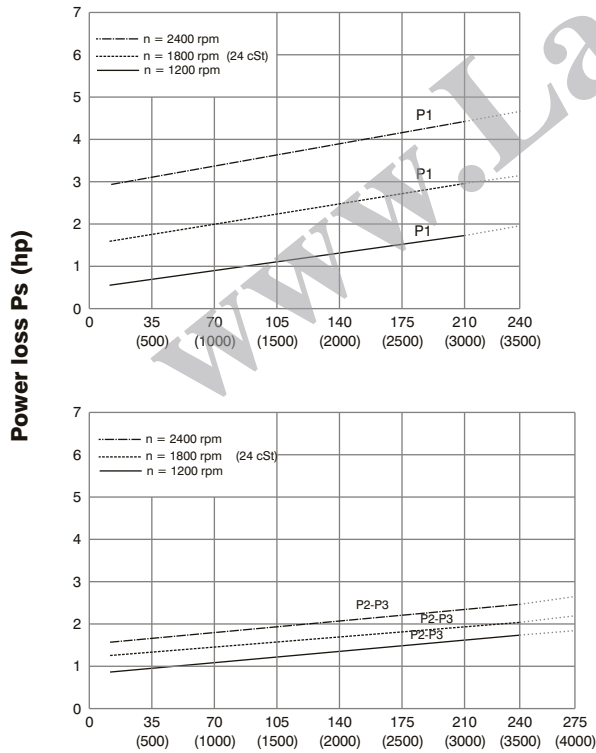

Pressure in bar (psi)

Total hydromechanical power loss is the sum of each section at its operating conditions.

## PERMISSIBLE RADIAL LOAD

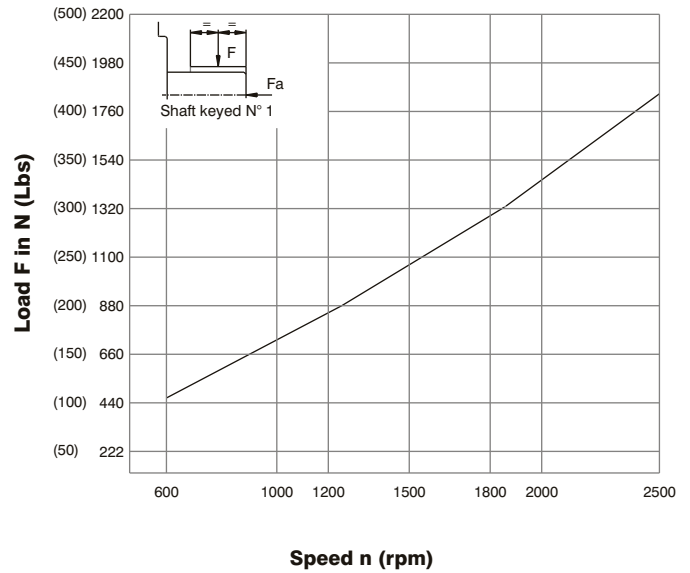

Speed n (rpm)

Maximum axial load permissible  $F_a=800\text{N}$  (180 Lbs)

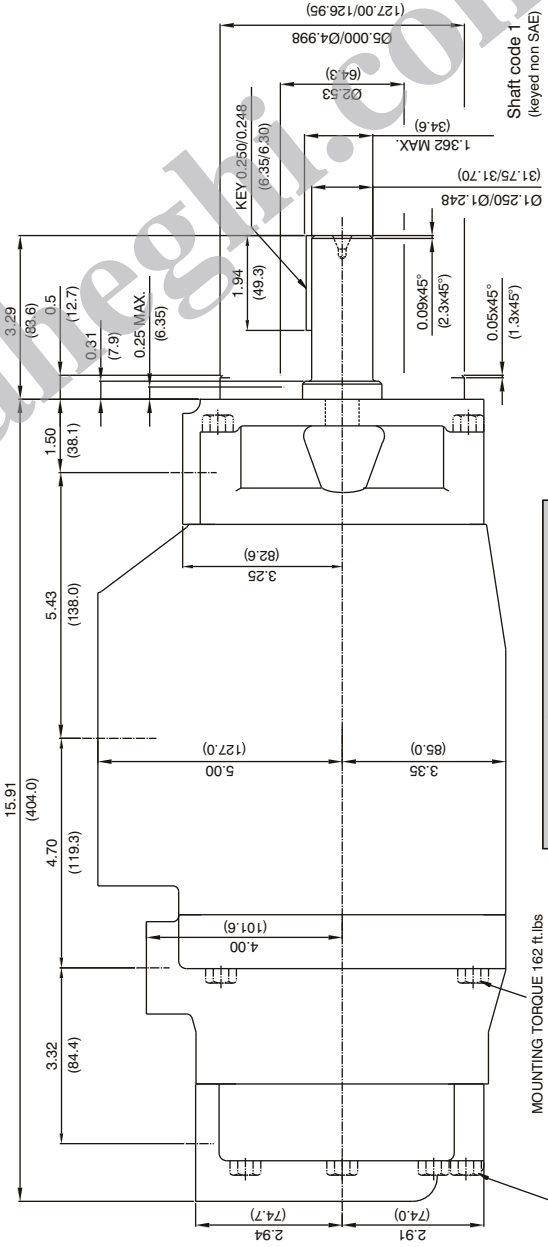
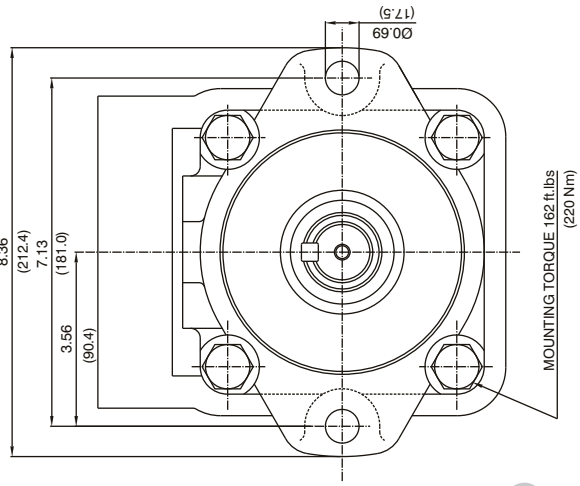
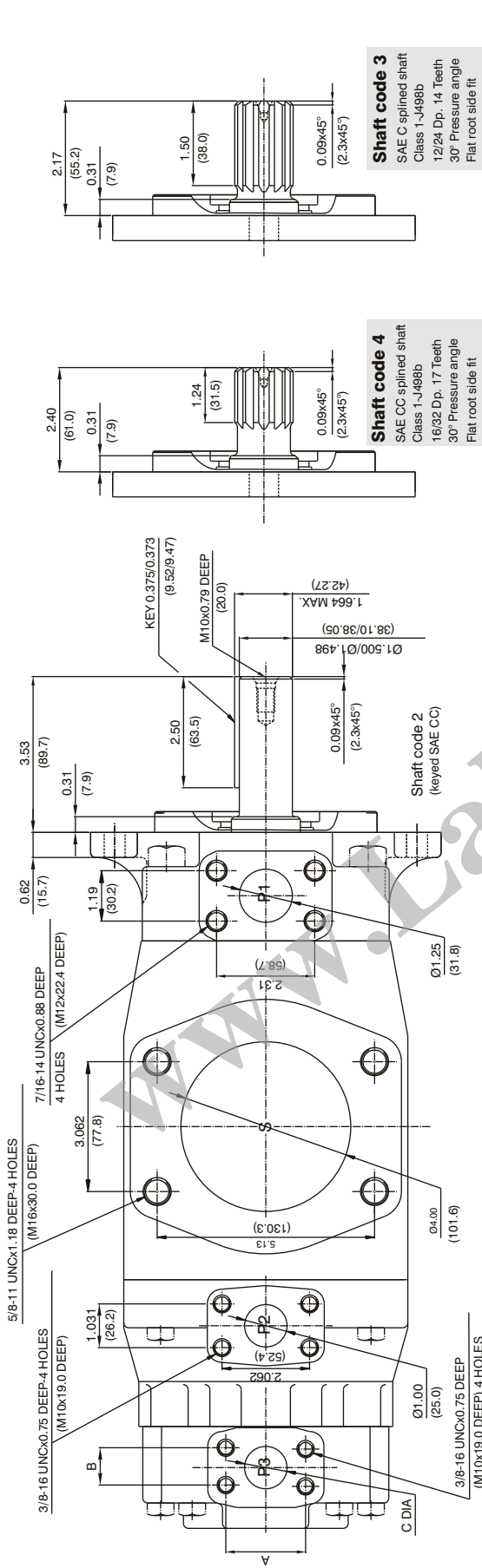

Alternate connection variables		
	Ø0 & M0	Ø1 & M1
A	2.063(52.4)	1.874(47.5)
B	1.031(26.1)	0.874(22.1)
C	1.000(25.4)	0.748(18.9)

Shaft	Vp x p max. (ml/rev x bar)
1	38289 (43240)
2	58901 (66500)
3	54207 (61200)
4	58901 (66500)

MOUNTING TORQUE 162 ft.lbs (220 Nm)

MOUNTING TORQUE 59 ft.lbs (80 Nm)

